



Is Now Part of



ON Semiconductor®

To learn more about ON Semiconductor, please visit our website at
www.onsemi.com

ON Semiconductor and the ON Semiconductor logo are trademarks of Semiconductor Components Industries, LLC dba ON Semiconductor or its subsidiaries in the United States and/or other countries. ON Semiconductor owns the rights to a number of patents, trademarks, copyrights, trade secrets, and other intellectual property. A listing of ON Semiconductor's product/patent coverage may be accessed at www.onsemi.com/site/pdf/Patent-Marking.pdf. ON Semiconductor reserves the right to make changes without further notice to any products herein. ON Semiconductor makes no warranty, representation or guarantee regarding the suitability of its products for any particular purpose, nor does ON Semiconductor assume any liability arising out of the application or use of any product or circuit, and specifically disclaims any and all liability, including without limitation special, consequential or incidental damages. Buyer is responsible for its products and applications using ON Semiconductor products, including compliance with all laws, regulations and safety requirements or standards, regardless of any support or applications information provided by ON Semiconductor. "Typical" parameters which may be provided in ON Semiconductor data sheets and/or specifications can and do vary in different applications and actual performance may vary over time. All operating parameters, including "Typicals" must be validated for each customer application by customer's technical experts. ON Semiconductor does not convey any license under its patent rights nor the rights of others. ON Semiconductor products are not designed, intended, or authorized for use as a critical component in life support systems or any FDA Class 3 medical devices or medical devices with a same or similar classification in a foreign jurisdiction or any devices intended for implantation in the human body. Should Buyer purchase or use ON Semiconductor products for any such unintended or unauthorized application, Buyer shall indemnify and hold ON Semiconductor and its officers, employees, subsidiaries, affiliates, and distributors harmless against all claims, costs, damages, and expenses, and reasonable attorney fees arising out of, directly or indirectly, any claim of personal injury or death associated with such unintended or unauthorized use, even if such claim alleges that ON Semiconductor was negligent regarding the design or manufacture of the part. ON Semiconductor is an Equal Opportunity/Affirmative Action Employer. This literature is subject to all applicable copyright laws and is not for resale in any manner.

KA78L05AI

3-Terminal 0.1 A 5 V Positive Voltage Regulator

Features

- Maximum Output Current of 100 mA
- Output Voltage of 5 V
- Thermal Overload Protection
- Short-Circuit Current Limiting
- Output Voltage Offered in $\pm 5\%$ Tolerance

Description

The KA78L05AI of fixed-voltage monolithic integrated circuit voltage regulators are suitable for applications that required supply current up to 100 mA.

SOT-89



1. Output 2. GND 3. Input

8-SOIC



1. Output 2. GND 3. GND 4. NC
5. NC 6. GND 7. GND 8. Input

Ordering Information

Product Number	Package	Packing Method	Output Voltage Tolerance	Operating Temperature
KA78L05AIDTF	8-SOIC	Tape and Reel	$\pm 5\%$	-40 to +125°C
KA78L05AIMTF	SOT-89	Tape and Reel		

Block Diagram

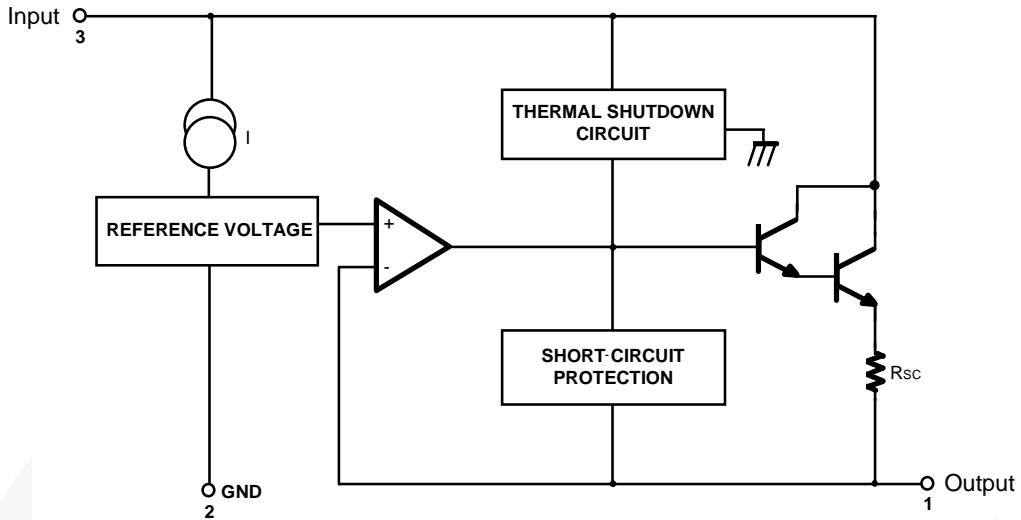

Figure 1. Block Diagram

Absolute Maximum Ratings⁽¹⁾

Stresses exceeding the absolute maximum ratings may damage the device. The device may not function or be operable above the recommended operating conditions and stressing the parts to these levels is not recommended. In addition, extended exposure to stresses above the recommended operating conditions may affect device reliability. The absolute maximum ratings are stress ratings only. Values are at $T_A = 25^\circ\text{C}$ unless otherwise noted.

Symbol	Parameter	Value	Unit
V_I	Input Voltage	30	V
T_J	Maximum Operating Junction Temperature	150	$^\circ\text{C}$
T_{OPR}	Operating Temperature Range	-40 to +125	$^\circ\text{C}$
T_{STG}	Storage Temperature Range	-65 to +150	$^\circ\text{C}$
$R_{\theta JA}$	Thermal Resistance Junction-Air	SOT-89	225 $^\circ\text{C/W}$
		8-SOIC	160 $^\circ\text{C/W}$

Note:

1. Absolute Maximum Ratings indicate limits beyond which damage to the device may occur. Electrical specifications do not apply when operating the device outside of its stated operating conditions.

Electrical Characteristics

$V_I = 10\text{ V}$, $I_O = 40\text{ mA}$, $-40^\circ\text{C} \leq T_J \leq 125^\circ\text{C}$, $C_I = 0.33\ \mu\text{F}$, $C_O = 0.1\ \mu\text{F}$, unless otherwise specified.

Symbol	Parameter	Conditions	Min.	Typ.	Max.	Unit	
V_O	Output Voltage	$T_J = 25^\circ\text{C}$	4.8	5.0	5.2	V	
ΔV_O	Line Regulation ⁽²⁾	$T_J = 25^\circ\text{C}$	$7\text{ V} \leq V_I \leq 20\text{ V}$		8	150	mV
			$8\text{ V} \leq V_I \leq 20\text{ V}$		6	100	mV
ΔV_O	Load Regulation ⁽²⁾	$T_J = 25^\circ\text{C}$	$1\text{ mA} \leq I_O \leq 100\text{ mA}$		11	60	mV
			$1\text{ mA} \leq I_O \leq 40\text{ mA}$		5.0	30.0	mV
V_O	Output Voltage	$7\text{ V} \leq V_I \leq 20\text{ V}$	$1\text{ mA} \leq I_O \leq 40\text{ mA}$	4.75		5.25	V
		$7\text{ V} \leq V_I \leq V_{\text{MAX}}^{(3)}$	$1\text{ mA} \leq I_O \leq 70\text{ mA}$	4.75		5.25	V
I_Q	Quiescent Current	$T_J = 25^\circ\text{C}$		2.0	5.5	mA	
ΔI_Q	Quiescent Current Change	With Line	$8\text{ V} \leq V_I \leq 20\text{ V}$			1.5	mA
ΔI_Q		With Load	$1\text{ mA} \leq I_O \leq 40\text{ mA}^{(4)}$			0.5	mA
V_N	Output Noise Voltage ⁽⁴⁾	$T_A = 25^\circ\text{C}$, $10\text{ Hz} \leq f \leq 100\text{ kHz}$		40		$\mu\text{V}/V_O$	
$\Delta V_O/\Delta T$	Temperature Coefficient of V_O ⁽⁴⁾	$I_O = 5\text{ mA}$		-0.65		$\text{mV}/^\circ\text{C}$	
RR	Ripple Rejection ^{(4), (5)}	$f = 120\text{ Hz}$, $8\text{ V} \leq V_I \leq 18\text{ V}$, $T_J = 25^\circ\text{C}$	41	80		dB	
V_D	Dropout Voltage	$T_J = 25^\circ\text{C}$		1.7		V	

Notes:

- The maximum steady-state usable output current and input voltage are very dependent on the heat sinking and/or lead length of the package. The data above represents pulse test conditions with junction temperature as indicated at the initiation of tests.
- Power dissipation $P_D \leq 0.75\text{ W}$.
- These parameters, although guaranteed over the recommended operating conditions, are not 100% tested in production.
- Recommend minimum load capacitance of $0.01\ \mu\text{F}$ to limit high-frequency noise.

Typical Application⁽⁶⁾

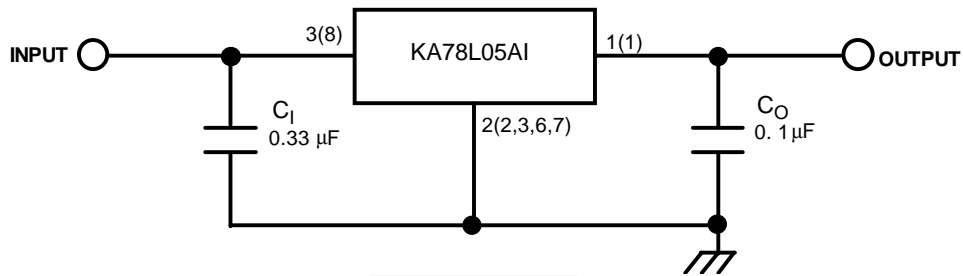

Figure 2. Typical Application

Note:

6. C_1 is required if the regulator is located an appreciable distance from the power supply filter. Though C_0 is not needed for stability, it improves transient response. Bypass capacitors are recommended for optimum stability and transient response and should be located as close as possible to the regulator.

Physical Dimensions

SOT-89

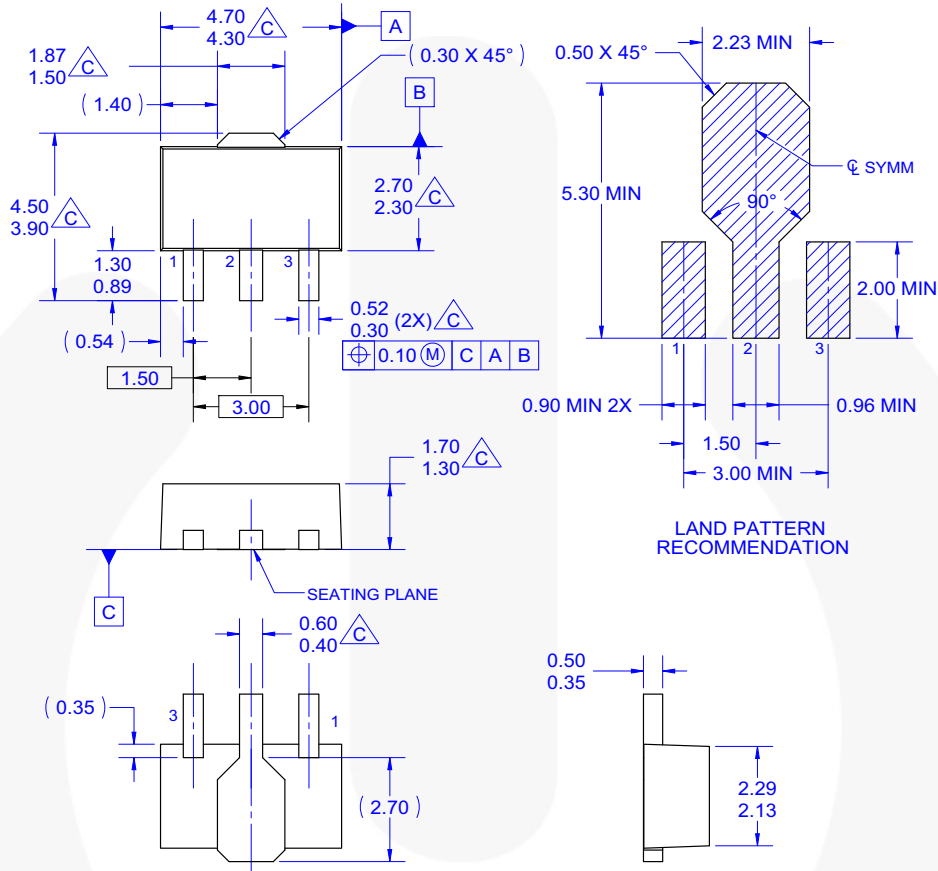

- NOTES: UNLESS OTHERWISE SPECIFIED.
- A. REFERENCE TO JEDEC TO-243 VARIATION AA.
 - B. ALL DIMENSIONS ARE IN MILLIMETERS.
 - C. DOES NOT COMPLY JEDEC STANDARD VALUE.
 - D. DIMENSIONS ARE EXCLUSIVE OF BURRS, MOLD FLASH AND TIE BAR PROTRUSION.
 - E. DIMENSION AND TOLERANCE AS PER ASME Y14.5-1994.
 - F. DRAWING FILE NAME: MA03CREV2

Figure 3. 3-Lead, SOT-89, JEDEC TO-243, Option AA

Package drawings are provided as a service to customers considering Fairchild components. Drawings may change in any manner without notice. Please note the revision and/or date on the drawing and contact a Fairchild Semiconductor representative to verify or obtain the most recent revision. Package specifications do not expand the terms of Fairchild's worldwide terms and conditions, specifically the warranty therein, which covers Fairchild products.

Always visit Fairchild Semiconductor's online packaging area for the most recent package drawings:
<http://www.fairchildsemi.com/packaging/>.

For current tape and reel specifications, visit Fairchild Semiconductor's online packaging area:
http://www.fairchildsemi.com/packaging/tr/sot89_tr.pdf.

Physical Dimensions (Continued)

8-SOIC

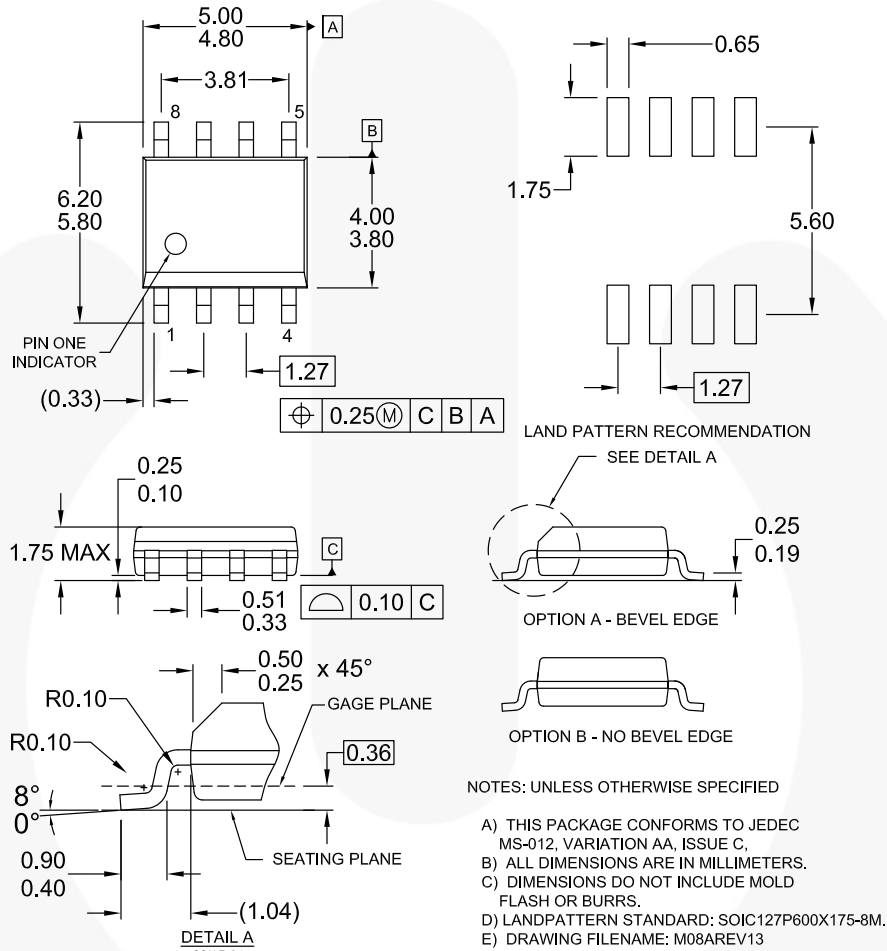

Figure 4. 8LD, SOIC, JEDEC MS-012, 0.150" NARROW BODY

Package drawings are provided as a service to customers considering Fairchild components. Drawings may change in any manner without notice. Please note the revision and/or date on the drawing and contact a Fairchild Semiconductor representative to verify or obtain the most recent revision. Package specifications do not expand the terms of Fairchild's worldwide terms and conditions, specifically the warranty therein, which covers Fairchild products.





Always visit Fairchild Semiconductor's online packaging area for the most recent package drawings:
<http://www.fairchildsemi.com/packaging/>

For current tape and reel specifications, visit Fairchild Semiconductor's online packaging area:
http://www.fairchildsemi.com/packaging/tr/soic8_tr.pdf



TRADEMARKS

The following includes registered and unregistered trademarks and service marks, owned by Fairchild Semiconductor and/or its global subsidiaries, and is not intended to be an exhaustive list of all such trademarks.

2Cool™	FPS™		Sync-Lock™
AccuPower™	F-PFS™	PowerTrench®	
AX-CAP®*	FRFET®	PowerXS™	TinyBoost™
BitSiC™	Global Power Resource SM	Programmable Active Droop™	TinyBuck™
Build it Now™	GreenBridge™	QFET®	TinyCalc™
CorePLUS™	Green FPS™	QS™	TinyLogic®
CorePOWER™	Green FPS™ e-Series™	Quiet Series™	TINYOPTO™
CROSSVOLT™	Gmax™	RapidConfigure™	TinyPower™
CTL™	GTO™		TinyPWM™
Current Transfer Logic™	IntelliMAX™	Saving our world, 1mW/W/kW at a time™	TinyWire™
DEUXPEED®	ISOPLANAR™	SignalWise™	TranSiC™
Dual Cool™	Making Small Speakers Sound Louder and Better™	SmartMax™	TriFault Detect™
EcoSPARK®	MegaBuck™	SMART START™	TRUECURRENT®*
EfficientMax™	MICROCOUPLER™	Solutions for Your Success™	μSerDes™
ESBC™	MicroFET™	SPM®	
	MicroPak™	STEALTH™	UHC®
Fairchild®	MicroPak2™	SuperFET®	Ultra FRFET™
Fairchild Semiconductor®	MillerDrive™	SuperSOT™-3	UniFET™
FACT Quiet Series™	MotionMax™	SuperSOT™-6	VXC™
FACT®	mWSaver™	SuperSOT™-8	VisualMax™
FAST®	OptoHi™	SupreMOS®	VoltagePlus™
FastvCore™	OPTOLOGIC®	SyncFET™	XS™
FETBench™	OPTOPLANAR®		

* Trademarks of System General Corporation, used under license by Fairchild Semiconductor.

DISCLAIMER

FAIRCHILD SEMICONDUCTOR RESERVES THE RIGHT TO MAKE CHANGES WITHOUT FURTHER NOTICE TO ANY PRODUCTS HEREIN TO IMPROVE RELIABILITY, FUNCTION, OR DESIGN. FAIRCHILD DOES NOT ASSUME ANY LIABILITY ARISING OUT OF THE APPLICATION OR USE OF ANY PRODUCT OR CIRCUIT DESCRIBED HEREIN; NEITHER DOES IT CONVEY ANY LICENSE UNDER ITS PATENT RIGHTS, NOR THE RIGHTS OF OTHERS. THESE SPECIFICATIONS DO NOT EXPAND THE TERMS OF FAIRCHILD'S WORLDWIDE TERMS AND CONDITIONS, SPECIFICALLY THE WARRANTY THEREIN, WHICH COVERS THESE PRODUCTS.

LIFE SUPPORT POLICY

FAIRCHILD'S PRODUCTS ARE NOT AUTHORIZED FOR USE AS CRITICAL COMPONENTS IN LIFE SUPPORT DEVICES OR SYSTEMS WITHOUT THE EXPRESS WRITTEN APPROVAL OF FAIRCHILD SEMICONDUCTOR CORPORATION.

As used herein:

1. Life support devices or systems are devices or systems which, (a) are intended for surgical implant into the body or (b) support or sustain life, and (c) whose failure to perform when properly used in accordance with instructions for use provided in the labeling, can be reasonably expected to result in a significant injury of the user.
2. A critical component in any component of a life support, device, or system whose failure to perform can be reasonably expected to cause the failure of the life support device or system, or to affect its safety or effectiveness.

ANTI-COUNTERFEITING POLICY

Fairchild Semiconductor Corporation's Anti-Counterfeiting Policy. Fairchild's Anti-Counterfeiting Policy is also stated on our external website, www.fairchildsemi.com, under Sales Support.

Counterfeiting of semiconductor parts is a growing problem in the industry. All manufacturers of semiconductor products are experiencing counterfeiting of their parts. Customers who inadvertently purchase counterfeit parts experience many problems such as loss of brand reputation, substandard performance, failed applications, and increased cost of production and manufacturing delays. Fairchild is taking strong measures to protect ourselves and our customers from the proliferation of counterfeit parts. Fairchild strongly encourages customers to purchase Fairchild parts either directly from Fairchild or from Authorized Fairchild Distributors who are listed by country on our web page cited above. Products customers buy either from Fairchild directly or from Authorized Fairchild Distributors are genuine parts, have full traceability, meet Fairchild's quality standards for handling and storage and provide access to Fairchild's full range of up-to-date technical and product information. Fairchild and our Authorized Distributors will stand behind all warranties and will appropriately address any warranty issues that may arise. Fairchild will not provide any warranty coverage or other assistance for parts bought from Unauthorized Sources. Fairchild is committed to combat this global problem and encourage our customers to do their part in stopping this practice by buying direct or from authorized distributors.

PRODUCT STATUS DEFINITIONS

Definition of Terms

Datasheet Identification	Product Status	Definition
Advance Information	Formative / In Design	Datasheet contains the design specifications for product development. Specifications may change in any manner without notice.
Preliminary	First Production	Datasheet contains preliminary data; supplementary data will be published at a later date. Fairchild Semiconductor reserves the right to make changes at any time without notice to improve design.
No Identification Needed	Full Production	Datasheet contains final specifications. Fairchild Semiconductor reserves the right to make changes at any time without notice to improve the design.
Obsolete	Not In Production	Datasheet contains specifications on a product that is discontinued by Fairchild Semiconductor. The datasheet is for reference information only.

ON Semiconductor and  are trademarks of Semiconductor Components Industries, LLC dba ON Semiconductor or its subsidiaries in the United States and/or other countries. ON Semiconductor owns the rights to a number of patents, trademarks, copyrights, trade secrets, and other intellectual property. A listing of ON Semiconductor's product/patent coverage may be accessed at www.onsemi.com/site/pdf/Patent-Marking.pdf. ON Semiconductor reserves the right to make changes without further notice to any products herein. ON Semiconductor makes no warranty, representation or guarantee regarding the suitability of its products for any particular purpose, nor does ON Semiconductor assume any liability arising out of the application or use of any product or circuit, and specifically disclaims any and all liability, including without limitation special, consequential or incidental damages. Buyer is responsible for its products and applications using ON Semiconductor products, including compliance with all laws, regulations and safety requirements or standards, regardless of any support or applications information provided by ON Semiconductor. "Typical" parameters which may be provided in ON Semiconductor data sheets and/or specifications can and do vary in different applications and actual performance may vary over time. All operating parameters, including "Typicals" must be validated for each customer application by customer's technical experts. ON Semiconductor does not convey any license under its patent rights nor the rights of others. ON Semiconductor products are not designed, intended, or authorized for use as a critical component in life support systems or any FDA Class 3 medical devices or medical devices with a same or similar classification in a foreign jurisdiction or any devices intended for implantation in the human body. Should Buyer purchase or use ON Semiconductor products for any such unintended or unauthorized application, Buyer shall indemnify and hold ON Semiconductor and its officers, employees, subsidiaries, affiliates, and distributors harmless against all claims, costs, damages, and expenses, and reasonable attorney fees arising out of, directly or indirectly, any claim of personal injury or death associated with such unintended or unauthorized use, even if such claim alleges that ON Semiconductor was negligent regarding the design or manufacture of the part. ON Semiconductor is an Equal Opportunity/Affirmative Action Employer. This literature is subject to all applicable copyright laws and is not for resale in any manner.

PUBLICATION ORDERING INFORMATION

LITERATURE FULFILLMENT:

Literature Distribution Center for ON Semiconductor
19521 E. 32nd Pkwy, Aurora, Colorado 80011 USA
Phone: 303-675-2175 or 800-344-3860 Toll Free USA/Canada
Fax: 303-675-2176 or 800-344-3867 Toll Free USA/Canada
Email: orderlit@onsemi.com

N. American Technical Support: 800-282-9855 Toll Free
USA/Canada
Europe, Middle East and Africa Technical Support:
Phone: 421 33 790 2910
Japan Customer Focus Center
Phone: 81-3-5817-1050

ON Semiconductor Website: www.onsemi.com
Order Literature: <http://www.onsemi.com/orderlit>
For additional information, please contact your local
Sales Representative