



Is Now Part of



ON Semiconductor®

To learn more about ON Semiconductor, please visit our website at
www.onsemi.com

ON Semiconductor and the ON Semiconductor logo are trademarks of Semiconductor Components Industries, LLC dba ON Semiconductor or its subsidiaries in the United States and/or other countries. ON Semiconductor owns the rights to a number of patents, trademarks, copyrights, trade secrets, and other intellectual property. A listing of ON Semiconductor's product/patent coverage may be accessed at www.onsemi.com/site/pdf/Patent-Marking.pdf. ON Semiconductor reserves the right to make changes without further notice to any products herein. ON Semiconductor makes no warranty, representation or guarantee regarding the suitability of its products for any particular purpose, nor does ON Semiconductor assume any liability arising out of the application or use of any product or circuit, and specifically disclaims any and all liability, including without limitation special, consequential or incidental damages. Buyer is responsible for its products and applications using ON Semiconductor products, including compliance with all laws, regulations and safety requirements or standards, regardless of any support or applications information provided by ON Semiconductor. "Typical" parameters which may be provided in ON Semiconductor data sheets and/or specifications can and do vary in different applications and actual performance may vary over time. All operating parameters, including "Typicals" must be validated for each customer application by customer's technical experts. ON Semiconductor does not convey any license under its patent rights nor the rights of others. ON Semiconductor products are not designed, intended, or authorized for use as a critical component in life support systems or any FDA Class 3 medical devices or medical devices with a same or similar classification in a foreign jurisdiction or any devices intended for implantation in the human body. Should Buyer purchase or use ON Semiconductor products for any such unintended or unauthorized application, Buyer shall indemnify and hold ON Semiconductor and its officers, employees, subsidiaries, affiliates, and distributors harmless against all claims, costs, damages, and expenses, and reasonable attorney fees arising out of, directly or indirectly, any claim of personal injury or death associated with such unintended or unauthorized use, even if such claim alleges that ON Semiconductor was negligent regarding the design or manufacture of the part. ON Semiconductor is an Equal Opportunity/Affirmative Action Employer. This literature is subject to all applicable copyright laws and is not for resale in any manner.



November 2014

MMBT2369A NPN Switching Transistor

Description

This device is designed for high speed saturated switching at collector currents of 10 mA to 100 mA. Sourced from process 21.

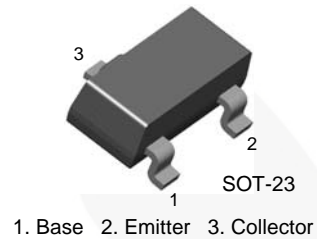

Ordering Information

Part Number	Marking	Package	Packing Method
MMBT2369A	1S	SOT-23 3L	Tape and Reel

Absolute Maximum Ratings^{(1),(2)}

Stresses exceeding the absolute maximum ratings may damage the device. The device may not function or be operable above the recommended operating conditions and stressing the parts to these levels is not recommended. In addition, extended exposure to stresses above the recommended operating conditions may affect device reliability. The absolute maximum ratings are stress ratings only. Values are at $T_A = 25^\circ\text{C}$ unless otherwise noted.

Symbol	Parameter	Value	Unit
V_{CEO}	Collector-Emitter Voltage	15	V
V_{CBO}	Collector-Base Voltage	40	V
V_{EBO}	Emitter-Base Voltage	4.5	V
I_C	Collector Current - Continuous	200	mA
T_J, T_{STG}	Operating and Storage Junction Temperature Range	-55 to +150	$^\circ\text{C}$

Notes:

1. These ratings are based on a maximum junction temperature of 150°C .
2. These are steady-state limits. Fairchild Semiconductor should be consulted on applications involving pulsed or low-duty-cycle operations.

Thermal Characteristics⁽³⁾Values are at $T_A = 25^\circ\text{C}$ unless otherwise noted.

Symbol	Parameter	Value	Unit
P_D	Total Device Dissipation	225	mW
	Derate Above 25°C	1.8	mW/ $^\circ\text{C}$
R_{qJA}	Thermal Resistance, Junction-to-Ambient	556	$^\circ\text{C}/\text{W}$

Note:

3. Device is mounted on FR-4 PCB 1.6 inch X 1.6 inch X 0.06 inch.

Electrical CharacteristicsValues are at $T_A = 25^\circ\text{C}$ unless otherwise noted.

Symbol	Parameter	Conditions	Min.	Max.	Unit
BV_{CEO}	Collector-Emitter Breakdown Voltage ⁽⁴⁾	$I_C = 10\text{ mA}, I_B = 0$	15		V
BV_{CES}	Collector-Emitter Breakdown Voltage	$I_C = 10\ \mu\text{A}, V_{BE} = 0$	40		V
BV_{CBO}	Collector-Base Breakdown Voltage	$I_C = 10\ \mu\text{A}, I_E = 0$	40		V
BV_{EBO}	Emitter-Base Breakdown Voltage	$I_E = 10\ \mu\text{A}, I_C = 0$	4.5		V
I_{CBO}	Collector Cut-Off Current	$V_{CB} = 20\text{ V}, I_E = 0$		0.4	μA
		$V_{CB} = 20\text{ V}, I_E = 0, T_A = 125^\circ\text{C}$		30	
h_{FE}	DC Current Gain ⁽⁴⁾	$I_C = 10\text{ mA}, V_{CE} = 1.0\text{ V}$	40	120	
		$I_C = 10\text{ mA}, V_{CE} = 0.35\text{ V}, T_A = -55^\circ\text{C}$	20		
		$I_C = 100\text{ mA}, V_{CE} = 1.0\text{ V}$	20		
$V_{CE(sat)}$	Collector-Emitter Saturation Voltage ⁽⁴⁾	$I_C = 10\text{ mA}, I_B = 1.0\text{ mA}$		0.20	V
		$I_C = 10\text{ mA}, I_B = 1.0\text{ mA}, T_A = 125^\circ\text{C}$		0.30	
		$I_C = 30\text{ mA}, I_B = 3.0\text{ mA}$		0.25	
		$I_C = 100\text{ mA}, I_B = 10\text{ mA}$		0.50	
$V_{BE(sat)}$	Base-Emitter Saturation Voltage	$I_C = 10\text{ mA}, I_B = 1.0\text{ mA}$	0.70	0.85	V
		$I_C = 10\text{ mA}, I_B = 1.0\text{ mA}, T_A = -55^\circ\text{C}$		1.02	
		$I_C = 10\text{ mA}, I_B = 1.0\text{ mA}, T_A = 125^\circ\text{C}$	0.59		
		$I_C = 30\text{ mA}, I_B = 3.0\text{ mA}$		1.15	
		$I_C = 100\text{ mA}, I_B = 10\text{ mA}$		1.60	
C_{obo}	Output Capacitance	$V_{CB} = 5.0\text{ V}, I_E = 0, f = 1.0\text{ MHz}$		4.0	pF
C_{ibo}	Input Capacitance	$V_{EB} = 0.5\text{ V}, I_C = 0, f = 1.0\text{ MHz}$		5.0	pF
h_{fe}	Small-Signal Current Gain	$I_C = 10\text{ mA}, V_{CE} = 10\text{ V}$ $R_G = 2.0\text{ k}\Omega, f = 100\text{ MHz}$	5.0		
t_s	Storage Time	$I_{B1} = I_{B2} = I_C = 10\text{ mA}$		13	ns
t_{on}	Turn-On Time	$V_{CC} = 3.0\text{ V}, I_C = 10\text{ mA},$ $I_{B1} = 3.0\text{ mA}$		12	ns
t_{off}	Turn-Off Time	$V_{CC} = 3.0\text{ V}, I_C = 10\text{ mA},$ $I_{B1} = 3.0\text{ mA}, I_{B2} = 1.5\text{ mA}$		18	ns

Note:4. Pulse test: Pulse width $\leq 300\ \mu\text{s}$, duty cycle $\leq 2\%$

Typical Performance Characteristics

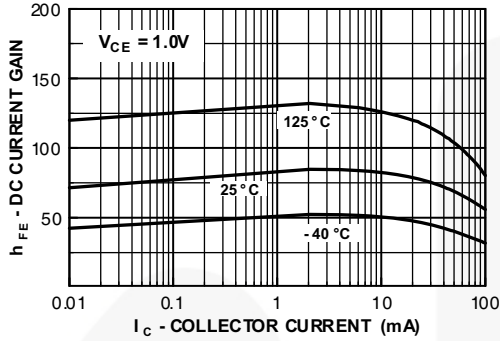

Figure 1. DC Current Gain vs. Collector Current

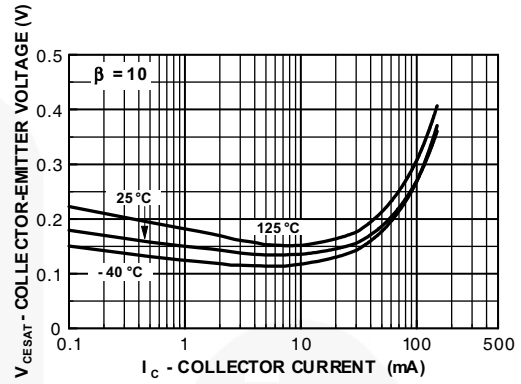

Figure 2. Collector-Emitter Saturation Voltage vs. Collector Current

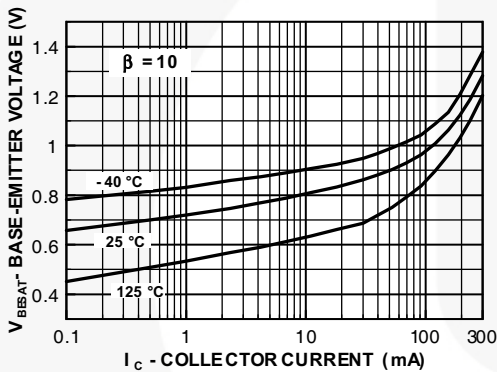

Figure 3. Base-Emitter Saturation Voltage vs. Collector Current

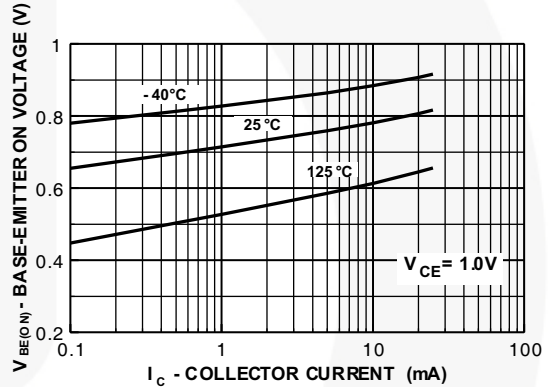

Figure 4. Base-Emitter On Voltage vs. Collector Current

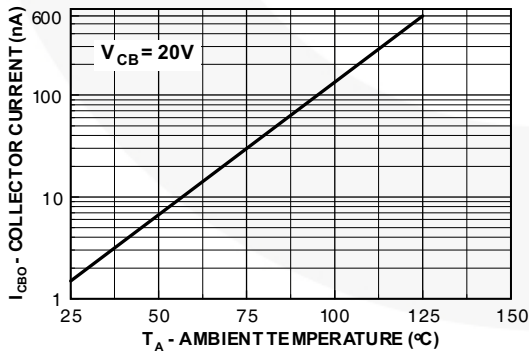

Figure 5. Collector Cut-Off Current vs. Ambient Temperature

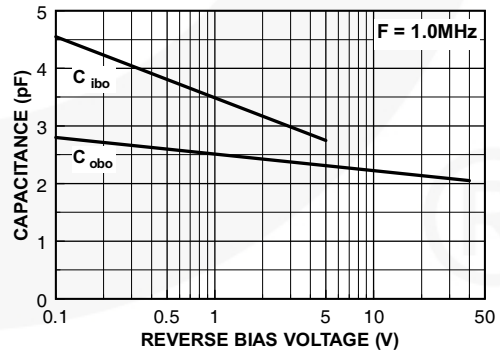

Figure 6. Output Capacitance vs. Reverse Bias Voltage

Typical Performance Characteristics (Continued)

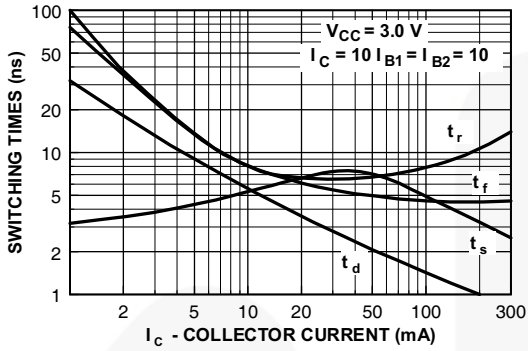

Figure 7. Switching Times vs. Collector Current

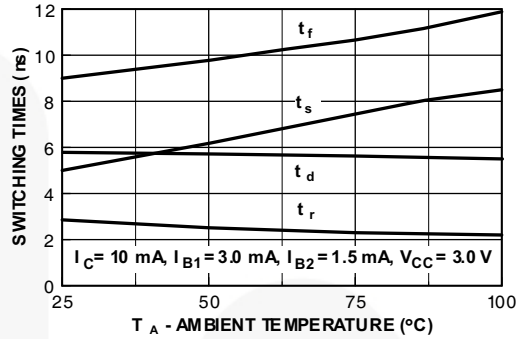

Figure 8. Switching Times vs. Ambient Temperature

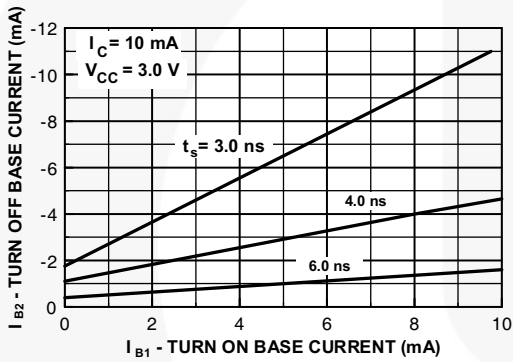

Figure 9. Storage Time vs. Turn-On and Turn-Off Base Currents

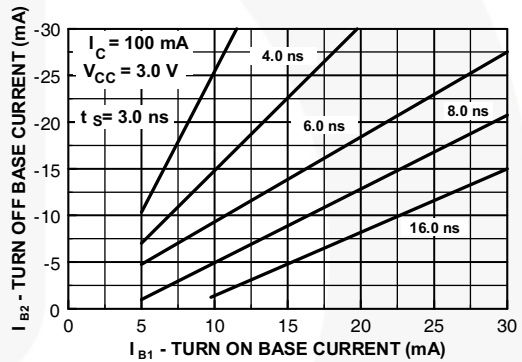

Figure 10. Storage Time vs. Turn-On and Turn-Off Base Currents

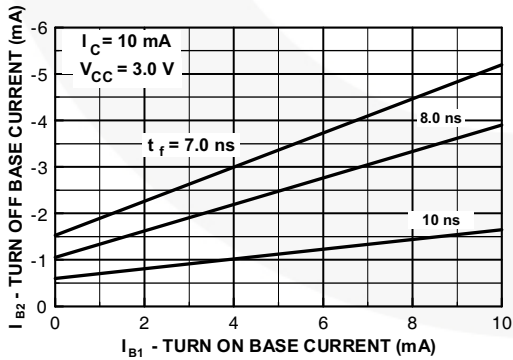

Figure 11. Fall Time vs. Turn-On and Turn-Off Base Currents

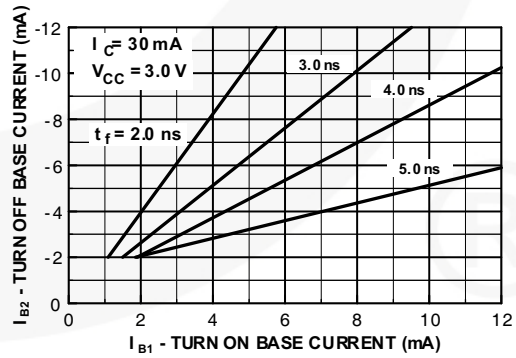

Figure 12. Fall Time vs. Turn-On and Turn-Off Base Currents

Typical Performance Characteristics (Continued)

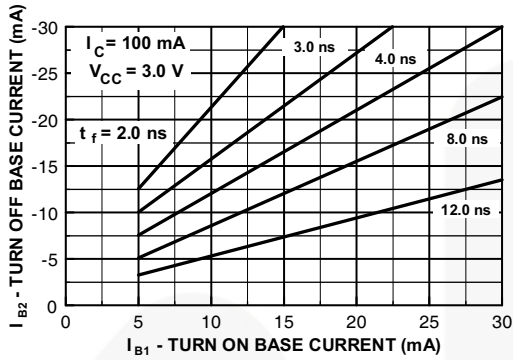

Figure 13. Fall Time vs. Turn-On and Turn-Off Base Currents

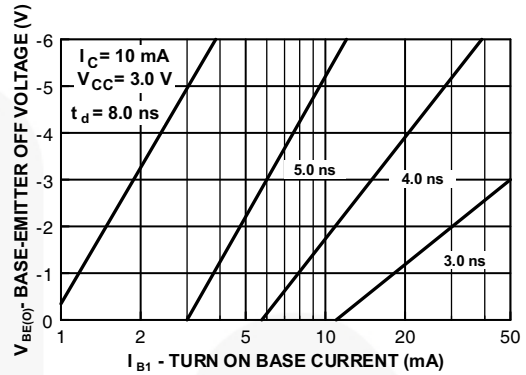

Figure 14. Delay Time vs. Base-Emitter Off Voltage and Turn-On Base Current

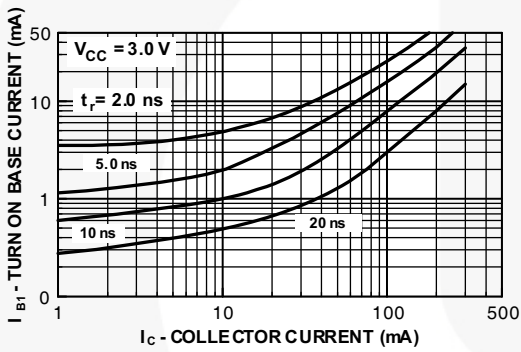

Figure 15. Rise Time vs. Turn-On Base Current and Collector Current

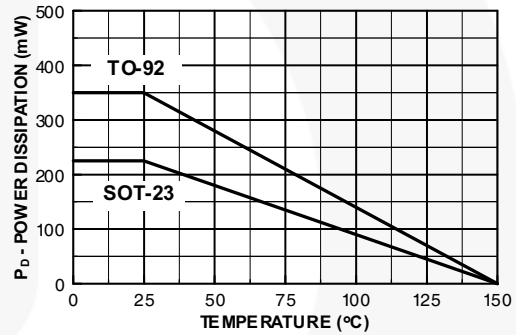
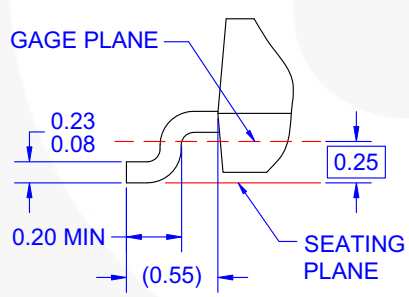
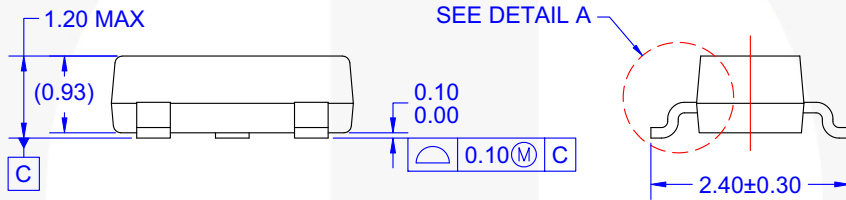
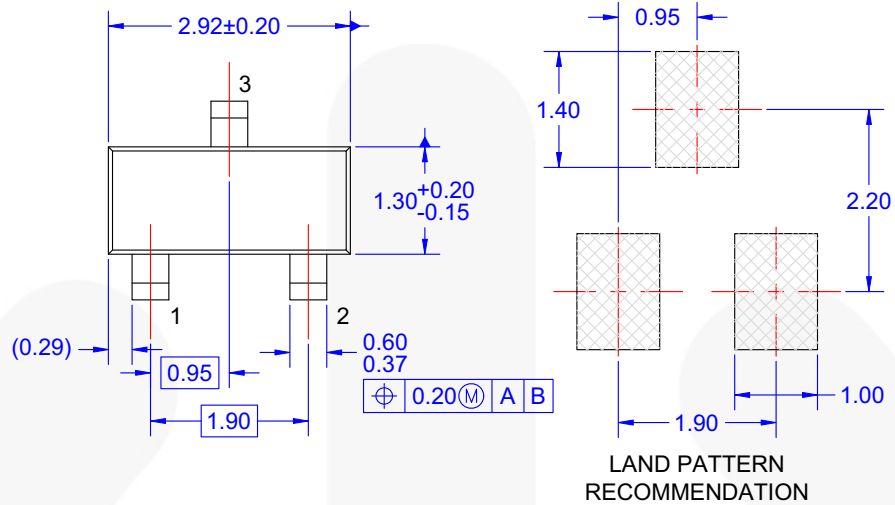

Figure 16. Power Dissipation vs. Ambient Temperature

Physical Dimensions



- NOTES: UNLESS OTHERWISE SPECIFIED
- A) REFERENCE JEDEC REGISTRATION TO-236, VARIATION AB, ISSUE H.
 - B) ALL DIMENSIONS ARE IN MILLIMETERS.
 - C) DIMENSIONS ARE INCLUSIVE OF BURRS, MOLD FLASH AND TIE BAR EXTRUSIONS.
 - D) DIMENSIONING AND TOLERANCING PER ASME Y14.5M - 1994.
 - E) DRAWING FILE NAME: MA03DREV10





DETAIL A
SCALE: 2X

Figure 17. 3-LEAD, SOT23, JEDEC TO-236, LOW PROFILE



TRADEMARKS

The following includes registered and unregistered trademarks and service marks, owned by Fairchild Semiconductor and/or its global subsidiaries, and is not intended to be an exhaustive list of all such trademarks.

- | | | | |
|--|--|---|---|
| AccuPower™ | F-PFS™ | OPTOPLANAR® |  SYSTEM GENERAL® |
| Awinda® | FRFET® |  ® | TinyBoost® |
| AX-CAP®* | Global Power Resource™ | PowerTrench® | TinyBuck® |
| BitSiC™ | GreenBridge™ | PowerXS™ | TinyCalc™ |
| Build it Now™ | Green FPS™ | Programmable Active Droop™ | TinyLogic® |
| CorePLUS™ | Green FPS™ e-Series™ | QFET® | TINYOPTO™ |
| CorePOWER™ | Gmax™ | QS™ | TinyPower™ |
| CROSSVOLT™ | GTO™ | Quiet Series™ | TinyPWM™ |
| CTL™ | IntelliMAX™ | RapidConfigure™ | TinyWire™ |
| Current Transfer Logic™ | ISOPANAR™ |  ™ | TranSiC™ |
| DEUXPEED® | Making Small Speakers Sound Louder and Better™ | Saving our world, 1mW/W/kW at a time™ | TriFault Detect™ |
| Dual Cool™ | MegaBuck™ | SignalWise™ | TRUECURRENT®* |
| EcoSPARK® | MICROCOUPLER™ | SmartMax™ | µSerDes™ |
| EfficientMax™ | MicroFET™ | SMART START™ |  SerDes™ |
| ESBC™ | MicroPak™ | Solutions for Your Success™ | UHC® |
|  Fairchild® | MicroPak2™ | SPM® | Ultra FRFET™ |
| Fairchild Semiconductor® | MillerDrive™ | STEALTH™ | UniFET™ |
| FACT Quiet Series™ | MotionMax™ | SuperFET® | VCX™ |
| FACT® | MotionGrid® | SuperSOT™-3 | VisualMax™ |
| FAST® | MTi® | SuperSOT™-6 | VoltagePlus™ |
| FastvCore™ | MTx® | SuperSOT™-8 | XS™ |
| FETBench™ | MVN® | SupreMOS® | Xsens™ |
| FPS™ | mWSaver® | SyncFET™ | 仙童™ |
| | OptoHiT™ | Sync-Lock™ | |
| | OPTOLOGIC® | | |

* Trademarks of System General Corporation, used under license by Fairchild Semiconductor.

DISCLAIMER

FAIRCHILD SEMICONDUCTOR RESERVES THE RIGHT TO MAKE CHANGES WITHOUT FURTHER NOTICE TO ANY PRODUCTS HEREIN TO IMPROVE RELIABILITY, FUNCTION, OR DESIGN. TO OBTAIN THE LATEST, MOST UP-TO-DATE DATASHEET AND PRODUCT INFORMATION, VISIT OUR WEBSITE AT [HTTP://WWW.FAIRCHILDSEMI.COM](http://www.fairchildsemi.com). FAIRCHILD DOES NOT ASSUME ANY LIABILITY ARISING OUT OF THE APPLICATION OR USE OF ANY PRODUCT OR CIRCUIT DESCRIBED HEREIN; NEITHER DOES IT CONVEY ANY LICENSE UNDER ITS PATENT RIGHTS, NOR THE RIGHTS OF OTHERS. THESE SPECIFICATIONS DO NOT EXPAND THE TERMS OF FAIRCHILD'S WORLDWIDE TERMS AND CONDITIONS, SPECIFICALLY THE WARRANTY THEREIN, WHICH COVERS THESE PRODUCTS.

LIFE SUPPORT POLICY

FAIRCHILD'S PRODUCTS ARE NOT AUTHORIZED FOR USE AS CRITICAL COMPONENTS IN LIFE SUPPORT DEVICES OR SYSTEMS WITHOUT THE EXPRESS WRITTEN APPROVAL OF FAIRCHILD SEMICONDUCTOR CORPORATION.

As used herein:

1. Life support devices or systems are devices or systems which, (a) are intended for surgical implant into the body or (b) support or sustain life, and (c) whose failure to perform when properly used in accordance with instructions for use provided in the labeling, can be reasonably expected to result in a significant injury of the user.
2. A critical component in any component of a life support, device, or system whose failure to perform can be reasonably expected to cause the failure of the life support device or system, or to affect its safety or effectiveness.

ANTI-COUNTERFEITING POLICY

Fairchild Semiconductor Corporation's Anti-Counterfeiting Policy. Fairchild's Anti-Counterfeiting Policy is also stated on our external website, www.fairchildsemi.com, under Sales Support.

Counterfeiting of semiconductor parts is a growing problem in the industry. All manufacturers of semiconductor products are experiencing counterfeiting of their parts. Customers who inadvertently purchase counterfeit parts experience many problems such as loss of brand reputation, substandard performance, failed applications, and increased cost of production and manufacturing delays. Fairchild is taking strong measures to protect ourselves and our customers from the proliferation of counterfeit parts. Fairchild strongly encourages customers to purchase Fairchild parts either directly from Fairchild or from Authorized Fairchild Distributors who are listed by country on our web page cited above. Products customers buy either from Fairchild directly or from Authorized Fairchild Distributors are genuine parts, have full traceability, meet Fairchild's quality standards for handling and storage and provide access to Fairchild's full range of up-to-date technical and product information. Fairchild and our Authorized Distributors will stand behind all warranties and will appropriately address any warranty issues that may arise. Fairchild will not provide any warranty coverage or other assistance for parts bought from Unauthorized Sources. Fairchild is committed to combat this global problem and encourage our customers to do their part in stopping this practice by buying direct or from authorized distributors.

PRODUCT STATUS DEFINITIONS

Definition of Terms

Datasheet Identification	Product Status	Definition
Advance Information	Formative / In Design	Datasheet contains the design specifications for product development. Specifications may change in any manner without notice.
Preliminary	First Production	Datasheet contains preliminary data; supplementary data will be published at a later date. Fairchild Semiconductor reserves the right to make changes at any time without notice to improve design.
No Identification Needed	Full Production	Datasheet contains final specifications. Fairchild Semiconductor reserves the right to make changes at any time without notice to improve the design.
Obsolete	Not In Production	Datasheet contains specifications on a product that is discontinued by Fairchild Semiconductor. The datasheet is for reference information only.

Rev. I72

ON Semiconductor and  are trademarks of Semiconductor Components Industries, LLC dba ON Semiconductor or its subsidiaries in the United States and/or other countries. ON Semiconductor owns the rights to a number of patents, trademarks, copyrights, trade secrets, and other intellectual property. A listing of ON Semiconductor's product/patent coverage may be accessed at www.onsemi.com/site/pdf/Patent-Marking.pdf. ON Semiconductor reserves the right to make changes without further notice to any products herein. ON Semiconductor makes no warranty, representation or guarantee regarding the suitability of its products for any particular purpose, nor does ON Semiconductor assume any liability arising out of the application or use of any product or circuit, and specifically disclaims any and all liability, including without limitation special, consequential or incidental damages. Buyer is responsible for its products and applications using ON Semiconductor products, including compliance with all laws, regulations and safety requirements or standards, regardless of any support or applications information provided by ON Semiconductor. "Typical" parameters which may be provided in ON Semiconductor data sheets and/or specifications can and do vary in different applications and actual performance may vary over time. All operating parameters, including "Typicals" must be validated for each customer application by customer's technical experts. ON Semiconductor does not convey any license under its patent rights nor the rights of others. ON Semiconductor products are not designed, intended, or authorized for use as a critical component in life support systems or any FDA Class 3 medical devices or medical devices with a same or similar classification in a foreign jurisdiction or any devices intended for implantation in the human body. Should Buyer purchase or use ON Semiconductor products for any such unintended or unauthorized application, Buyer shall indemnify and hold ON Semiconductor and its officers, employees, subsidiaries, affiliates, and distributors harmless against all claims, costs, damages, and expenses, and reasonable attorney fees arising out of, directly or indirectly, any claim of personal injury or death associated with such unintended or unauthorized use, even if such claim alleges that ON Semiconductor was negligent regarding the design or manufacture of the part. ON Semiconductor is an Equal Opportunity/Affirmative Action Employer. This literature is subject to all applicable copyright laws and is not for resale in any manner.

PUBLICATION ORDERING INFORMATION

LITERATURE FULFILLMENT:

Literature Distribution Center for ON Semiconductor
19521 E. 32nd Pkwy, Aurora, Colorado 80011 USA
Phone: 303-675-2175 or 800-344-3860 Toll Free USA/Canada
Fax: 303-675-2176 or 800-344-3867 Toll Free USA/Canada
Email: orderlit@onsemi.com

N. American Technical Support: 800-282-9855 Toll Free
USA/Canada
Europe, Middle East and Africa Technical Support:
Phone: 421 33 790 2910
Japan Customer Focus Center
Phone: 81-3-5817-1050

ON Semiconductor Website: www.onsemi.com
Order Literature: <http://www.onsemi.com/orderlit>
For additional information, please contact your local
Sales Representative